

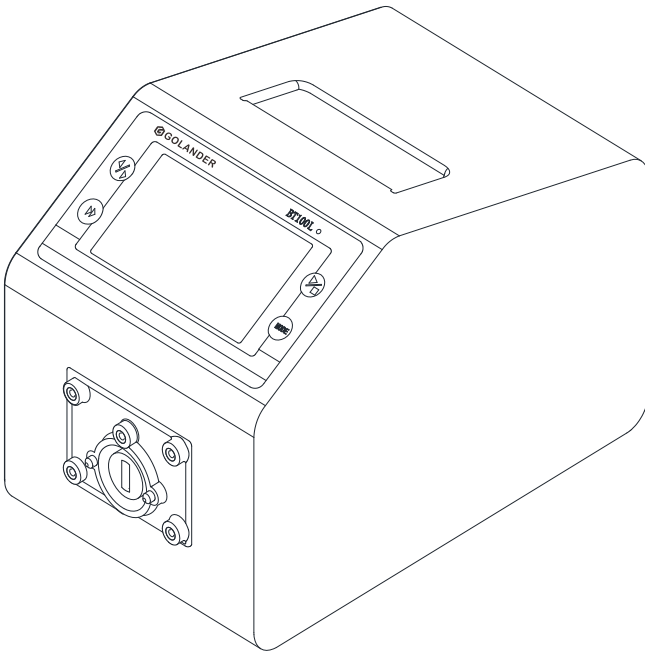

BT100L/300L/600L (V3)
Intelligent Flow Peristaltic Pump
Operating Manual



Contents

Safety Precautions	1
1 Description	6
2 Functions and Features.....	6
3 Components and Connectors.....	8
4 Operating Keypad and Display Panel.....	9
4.1 Keypad.....	9
4.2 LCD Touch Screen Display.....	9
4.2.1 Status Bar	10
4.2.2 Operation Display.....	10
4.2.3 Navigation	11
5 External Control Interface.....	21
6 Operation Instructions	22
6.1 Before Operation.....	22
6.2 Power Connection.....	23
6.3 First Run Wizard	23
6.4 Working Mode	26
6.5 External Control Mode.....	29
6.6 Communication mode	31
6.7 Footswitch	33
7 Maintenance	34
7.1 Warranty	34
7.2 Regular Maintenance	34
7.3 Malfunction Solutions	34
8 Dimensions	36
9 Naming Rule	36
10 Specifications.....	37

Safety Precautions



Danger

- Use the correct voltage indicated on the rating plate label of the pump to avoid any damage.
- Do not make any unauthorized dismantling, changes, or modifications to the pump which could result in malfunctions or even potential accidents.
- Turn off the pump drive before installing or removing tubing, attempting any maintenance, cleaning, or repair of the drive, connecting, or disconnecting external control devices or a communication interface. Fingers or loose clothing could get caught in the drive mechanism.



Warning

- Ensure no chemical reactions occur between the handled fluid with the material of the pump head and tubing before use.
- Tubing should be checked regularly to avoid breakage. Tubing breakage may result in fluid being sprayed from the pump. Use appropriate measures to protect the operator and equipment. The operator is solely liable for damages resulting from tubing breakage, particularly the leakage of toxic or valuable liquids.
- The pump is provided with a grounded plug which must be always well grounded.
- This device is not designed for nor intended for usage in patient-connected applications, including but not limited to medical and dental use.
- Observe all other applicable regulations concerning working safety, operational safety, environmental protection, and relevant local regulations.

(DE) SICHERHEITSHINWEISE



Gefahr

- Verwenden Sie die richtige Spannung, die auf dem Typenschild der Pumpe angegeben ist, um Schäden zu vermeiden.
- Nehmen Sie keine unbefugten Demontagen, Änderungen oder Modifikationen an der Pumpe vor, die zu Fehlfunktionen oder sogar zu Unfällen führen könnten.
- Schalten Sie den Pumpenantrieb aus, bevor Sie Schläuche ein- oder ausbauen, Wartungs-, Reinigungs- oder Reparaturarbeiten am Antrieb vornehmen oder externe Steuergeräte oder eine Kommunikationsschnittstelle anschließen oder trennen. Finger oder lose Kleidungsstücke können sich im Antriebsmechanismus verfangen.



Warnung

- Vergewissern Sie sich vor der Verwendung, dass keine chemischen Reaktionen zwischen dem Fördermedium und dem Material des Pumpenkopfs und der Schläuche auftreten können.
- Die Schläuche sollten regelmäßig überprüft werden, um Brüche zu vermeiden. Ein Schlauchbruch kann dazu führen, dass Flüssigkeit aus der Pumpe spritzt. Ergreifen Sie geeignete Maßnahmen zum Schutz des Bedieners und der Ausrüstung. Der Betreiber haftet allein für Schäden, die durch einen Schlauchbruch entstehen, insbesondere für das Austreten von giftigen oder wertvollen Flüssigkeiten.
- Die Pumpe ist mit einem geerdeten Stecker ausgestattet, der stets korrekt an eine abgesicherte Netzsteckdose angeschlossen sein muss. Dieses Gerät ist nicht für Anwendungen ausgelegt oder vorgesehen, die im Zusammenhang mit der Behandlung von Patienten stehen. Medizinische bzw. zahnmedizinische Anwendungen sind nicht bestimmungsgemäß.
- Beachten Sie alle anderen geltenden Vorschriften zur Arbeitssicherheit, zur Betriebssicherheit, zum Umweltschutz sowie die einschlägigen örtlichen Vorschriften.

(FR) CONSIGNES DE SÉCURITÉ



Danger

- Utilisez la tension correcte indiquée sur la plaque signalétique de la pompe afin d'éviter tout dommage.
- Ne procédez pas à des démontages, changements ou modifications non autorisés de la pompe qui pourraient entraîner des dysfonctionnements, voire des accidents.
- Mettez l'entraînement de la pompe hors tension avant d'installer ou de retirer des tuyaux, d'effectuer des travaux d'entretien, de nettoyage ou de réparation sur l'entraînement ou de connecter ou déconnecter des dispositifs de commande externes ou une interface de communication. Des doigts ou des vêtements lâches pourraient se prendre dans le mécanisme d'entraînement.



Avertissement

- Avant toute utilisation, assurez-vous qu'il n'y a pas de réaction chimique entre le liquide pompé et le matériau de la tête de pompe et des tubes.
- Les tuyaux doivent être contrôlés régulièrement pour éviter les ruptures. Une rupture de tuyau peut entraîner des projections de liquide hors de la pompe. Prenez les mesures appropriées pour protéger l'opérateur et l'équipement. L'opérateur est seul responsable des dommages causés par une rupture de tuyau, notamment en cas de fuite de liquides toxiques ou précieux.
- La pompe est équipée d'une fiche de mise à la terre qui doit toujours être bien reliée à la terre.
- Cet appareil n'est pas conçu ni prévu pour être utilisé en présence de patients, y compris, mais sans s'y limiter, dans le cadre d'applications médicales et dentaires.
- Respectez toutes les autres réglementations applicables en matière de sécurité du travail, de sécurité d'exploitation, de protection de l'environnement.

(ES) INSTRUCCIONES DE SEGURIDAD



Peligro

- Utilice la tensión correcta indicada en la placa de características de la bomba para evitar daños.
- No realice ningún desmontaje, cambio o modificación no autorizada en la bomba que pueda provocar un mal funcionamiento o incluso accidentes.
- Desconecte el accionamiento de la bomba antes de instalar o retirar las mangueras, realizar trabajos de mantenimiento, limpieza o reparación en el accionamiento o conectar o desconectar dispositivos de control externos o una interfaz de comunicación. Los dedos o la ropa suelta podrían quedar atrapados en el mecanismo de accionamiento.



Advertencia

- Antes de usarla, asegúrese de que no hay reacciones químicas entre el medio bombeado y el material de la cabeza de la bomba y las mangueras.
- Las mangueras deben ser revisadas regularmente para evitar roturas. La rotura de una manguera puede hacer que salga líquido de la bomba. Tome las medidas adecuadas para proteger al operador y al equipo. El operador es el único responsable de los daños causados por la rotura de una manguera, especialmente por la fuga de líquidos tóxicos o valiosos.
- La bomba está equipada con un enchufe con toma de tierra que debe estar siempre bien conectado a tierra.
- Este aparato no está diseñado ni pensado para su uso en relación con los pacientes, incluyendo pero sin limitarse a las aplicaciones médicas y dentales.
- Respetar todas las demás normas aplicables en materia de seguridad laboral, seguridad operativa y protección del medio ambiente.

(IT) ISTRUZIONI DI SICUREZZA



Pericolo

- Usare la tensione corretta indicata sull'etichetta della targhetta della pompa per evitare qualsiasi danno.
- Non eseguire smontaggi, cambiamenti o modifiche non autorizzati alla pompa che potrebbero causare malfunzionamenti o addirittura potenziali incidenti.
- Spegnerne l'azionamento della pompa prima d'installare o rimuovere tubi, tentare qualsiasi manutenzione, pulizia o riparazione dell'azionamento, collegare o scollegare dispositivi di controllo esterni o un'interfaccia di comunicazione. Dita o indumenti larghi potrebbero rimanere impigliati nel meccanismo di azionamento.



Attenzione

- Assicurarsi che non si verifichino reazioni chimiche tra il fluido trattato e il materiale della testa della pompa e dei tubi prima dell'uso.
- I tubi devono essere controllati regolarmente per evitare rotture. La rottura del tubo può provocare spruzzi di fluido dalla pompa. Utilizzare misure appropriate per proteggere l'operatore e l'attrezzatura. L'operatore è l'unico responsabile dei danni derivanti dalla rottura dei tubi, in particolare della fuoriuscita di liquidi tossici o preziosi.
- La pompa è dotata di una spina con messa a terra che deve essere sempre ben collegata a terra.
- Questo dispositivo non è progettato né destinato all'uso in applicazioni collegate al paziente, incluso ma non limitato all'uso medico e dentistico.
- Osservare tutte le altre norme applicabili riguardanti la sicurezza sul lavoro, la sicurezza operativa, la protezione dell'ambiente e le norme locali pertinenti.

1 Description

The BT-L series of intelligent peristaltic flow pumps is designed to deliver high-precision flow transmission. The latest iteration of this series features a larger true color LCD touch screen, significantly enhancing user-friendliness and providing a more comprehensive display of information. Moreover, the RS485 MODBUS interface has been expanded with additional settings, facilitating improved communication with external devices and enabling more effective control.

The BT-L series comprises the following models:

- BT100L, flow rate: 0.0001-720 mL/min, speed: 0.1-150 rpm
- BT300L, flow rate: 0.006-1600 mL/min, speed: 0.1-350 rpm
- BT600L, flow rate: 0.006-2900 mL/min, speed: 0.1-600 rpm

2 Functions and Features

Peristaltic pumps excel in handling abrasive, corrosive, and viscous fluids without encountering issues like seal contact or valve clogging. Fluid contacts only the tubing or tube material. These pumps can achieve suction lift and prime up to 8m water column at sea level. They can effectively handle shear-sensitive fluids like latex or firefighting foam with minimal shearing. Moreover, peristaltic pumps can operate without liquid, making them suitable for pumping fluids with significant amounts of entrained air, such as black liquor soap. Their high volumetric efficiency makes them ideal for metering or dosing applications that require exceptional accuracy. Additionally, tubing and tube materials specifically designed for food and pharmaceutical applications are readily available.

- The pump features a color LCD touchscreen and an operational keypad.
- It offers reversible direction, start/stop control, and adjustable speed with a precision rotating speed control of 0.2% and 0.1 rpm speed.

- The inclusion of flow display and calibration, along with Time Dispense Mode, makes it ideal for fluid transfer applications.
- The pump can store up to 5 groups of working parameters, allowing for convenient recall and setup.
- With intelligent temperature control and an optically isolated external logic level signal for start/stop, direction, and easy dispense functions, as well as an external analog signal for adjusting the rotating speed, it delivers exceptional efficiency.
- The RS485 MODBUS interface enables seamless control by external devices, enhancing connectivity and integration.
- Its internal double-deck isolation structure, conformal coated circuit board, and anti-electromagnetic interference feature provide excellent dust- and moisture-proofing, while the wide input voltage range ensures compatibility with diverse power environments.
- The stainless-steel enclosure not only facilitates easy cleaning but also renders the pump resistant to corrosion from acid, alkali, sodium, and organic solvents.
- Please note that the WIFI function is currently unavailable in North America or Europe.

3 Components and Connectors

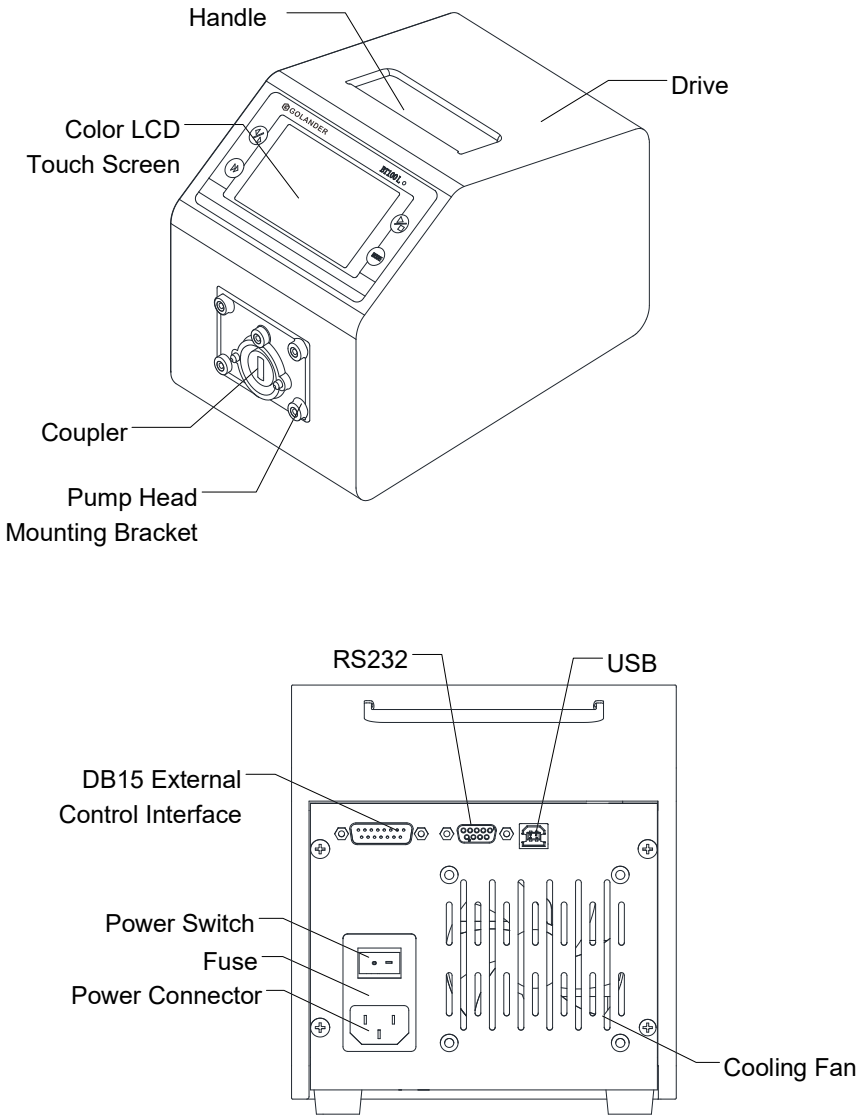

Figure 1. Components and Connectors

4 Operating Keypad and Display Panel

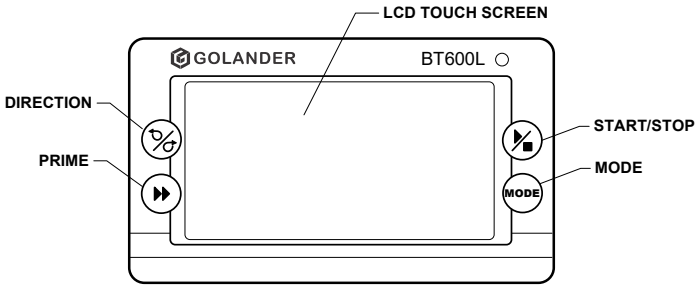





Figure 2. Display Panel

4.1 Keypad

-  **START/STOP** key. Press to start or stop the pump.
-  **DIRECTION** key. Press to change the pump's rotating direction between clockwise and counterclockwise.
-  **PRIME** key. Enables maximum speed operation; press again to return to the previous state.
-  **MODE** key. Press to select a working mode and to display content when the pump is not running or the keypad is locked.

4.2 LCD Touch Screen Display

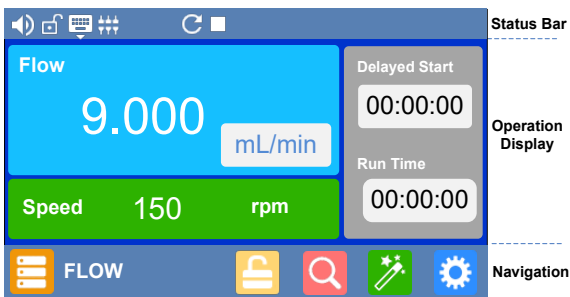











Figure 3. Main Screen

4.2.1 Status Bar

	Tone On/Off		Keypad Locked/Unlocked
	Internal Control Mode		Footswitch Mode
	Current Mode		Voltage Mode
	Communication Connected		Communication Disconnected
	Rotation Direction		Running/Stop

4.2.2 Operation Display

Flow: When the pump is not running, press the flow value to input the desired value in the pop-up window. Please pay attention to the flow range limit and the unit of flow rate.

FLOW			
Max: 9.0mL/min		Min: 6.0uL/min	
<input type="text"/>			Del
1	2	3	.
4	5	6	0
7	8	9	OK

Figure 4 Flow Rate Setting

Flow Unit: When the pump is not running, press the flow unit to select from the available units: uL/min, mL/min, and L/min (see Figure 5).

Flow Unit	X
uL/min	<input checked="" type="radio"/>
mL/min	<input type="radio"/>
L/min	<input type="radio"/>

Figure 5 Choose the Flow Rate Unit

Speed: When the pump is not running, press the speed value to input the desired speed in the pop-up window. Please pay attention to the speed limit.

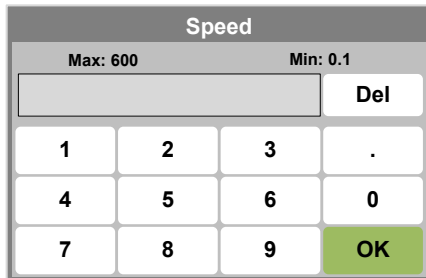













Figure 6 Speed Setting

Delayed Start: A delayed start can be preset (see section 6.4).

Run Time: The operation time can be preset (see section 6.4).

4.2.3 Navigation

	Mode Settings		Lock/Unlock
	Preview		Calibration
	Main Menu		Quick Settings
	Previous Step/Previous Page		Next step/Next page
	Confirm		Exit/Return
	Decrease		Increase



Mode Settings - Press the icon to access the “Mode Setting” interface for customizing control modes, including options for key tone on/off. Press “Control Mode” to access a pop-up screen with five control modes: internal control, foot switch, current control 4-20mA, voltage control 0-5V, and voltage control 0-10V.

Mode Settings	
Control Mode Internal Control	
Reserved	
Sound	<input checked="" type="checkbox"/>
Reserved	<input type="checkbox"/>

Control Mode	
Internal Control	<input checked="" type="radio"/>
Foot Switch	<input type="radio"/>
Current Control 4-20mA	<input type="radio"/>
Voltage Control 0-5V	<input type="radio"/>
Voltage Control 0-10V	<input type="radio"/>

Figure 7 Control Mode Settings



Lock/Unlock - Press the icon to lock the screen, and press again to unlock the screen. A password is required to unlock the screen. If no password is set, leave it blank and press OK directly.



Preview - View running status and parameter changes. The current running parameters are displayed on the left side of the interface, while the running status is shown on the right side.

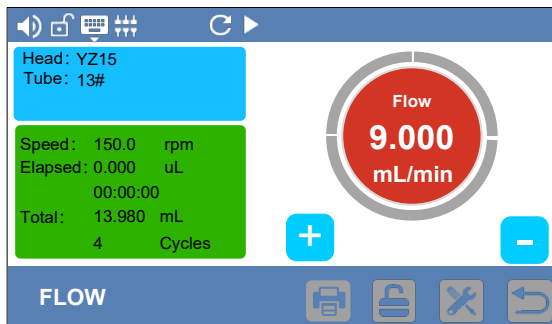

Figure 8 Preview Interface

In flow mode, red at the center indicates a stop, green signifies operation, and the current flow rate is displayed in the middle.

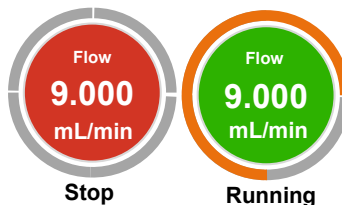

Figure 9 Running Status Display

The rotating ring shows the direction of the pump operation.

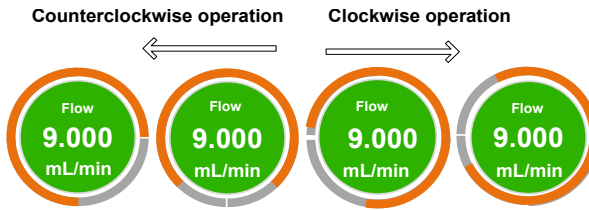

Figure 10 Direction Indication

In dispense mode, red at the center indicates a stop, green signifies operation, and yellow denotes a pause.

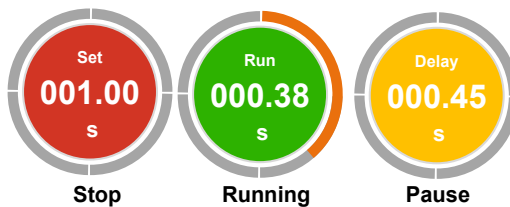

Figure 11 Dispense Status Indication

Real-time Flow Rate Adjustment: Instantly adjust the flow rate of the peristaltic pump, whether it's running or not. Increase or decrease the flow rate by briefly pressing the plus (+) or minus (-) icon. For swift changes, press and hold the icon.



Increase



Decrease

Figure 12 Flow Rate Adjustment Button



Printer - When a thermal printer is connected to the pump, you can print operating diameters at any time by pressing this icon.



Lock/Unlock - Press the icon to lock the screen, and press again to unlock the screen. A password is required to unlock the screen. If no password is set, leave it blank and press OK directly.



Quick Settings - Clear accumulative volume and accumulative cycles, and enable or disable tone.

Quick Settings	
Cumulative Volume	
Cumulative Cycles	
Sound	<input checked="" type="checkbox"/>
Reserved	

Figure 13 Quick Settings



Calibration - For an accurate flow rate display, it is crucial to perform flow rate calibration. Follow the step-by-step instructions provided by the calibration wizard (see section [6.3](#)). Measure the transferred liquid using a balance or measuring cylinder to ensure precise alignment between the displayed value and the actual flow rate.

4.2.4 Main Menu



Main Menu - Press the icon when the pump is not running to access the Main Menu.



Figure 14 Main Menu

Setup - To set up the general settings, swipe up and down to view the menu, details as in Figure 15.

General Setting	
Pump Head YZ15	>
Tubing 13#	>
Anti-Drip 0°	>
Anti-Speed 150RPM	>
Communication	>

Figure 15 General Settings

- **Pump Head:** Choose the correct model of the installed pump head from the menu. Access the menu by swiping up and down, as shown in Figure 16.

Pump Head	
	YZ15 <input checked="" type="radio"/>
	YT15 <input type="radio"/>
	WMD15 <input type="radio"/>
	YZ25 <input type="radio"/>

Figure 16 Pump Head Selection

- **Tubing:** Choose the appropriate tubing for the selected pump head. Swipe up and down to view the available options in the menu, as shown in Figure 17.

Tube Settings	
 Min Flow 6.000 uL/min Max Flow 9.000 mL/min	13# <input checked="" type="radio"/>
	14# <input type="radio"/>
	19# <input type="radio"/>
	16# <input type="radio"/>

Figure 17 Tubing Selection

- **Anti-Drip:** The peristaltic pump is designed to rotate in reverse by a specified angle when it stops, preventing fluid from dripping from the tubing. You can either choose from preset angles or input custom values to define the back suction angle. Setting the angle to 0 disables this function.

Anti-Drip	
0	
180	
360	
720	
Set Other Value	

Figure 18 Anti-drip Settings

- **Anti-Speed:** Set the reverse speed as needed.

Anti-Speed			
Max: 600		Min: 1	
<input type="text"/>			Del
1	2	3	.
4	5	6	0
7	8	9	OK

Figure 19 Anti-Speed Setting

- **Communication:** Sets the parameters of RS485 communication, as shown in Figure 20.

Communication Settings	
Baud(bps)	9600
Parity Bit	EVEN
Byte Order	CDAB
Pump No.	1

Figure 20 Communication Settings

When a password is set and entered (the default password is blank), additional parameter settings will be displayed in the general settings menu. Swipe up and down to navigate through the menu options.

General Settings	
External Direction Pulse signal	
Deceleration Time 0.5S	
Pulse Control Falling edge	
Level Control Low level	

Figure 21 General Settings (Advanced)

- **External Direction:** Choose the type of external signal, level or pulse, to control the direction. When set to "Level," the direction changes when an external signal is closed or opened, similar to working with a maintained switch. When set to "Pulse," the direction changes when the signal is closed and then opened again, resembling a normally-open momentary switch.
- **Deceleration Time:** Specifies the time required for the drive to decelerate from running speed to 0. This setting helps reduce fluid splash at the end of a dispense.
- **Pulse Control:** When the external direction signal is a pulse signal, you can set a falling or rising edge to change the direction. A falling edge refers to a change from a high to a low level, while a rising edge refers to a change from a low to a high level.
- **Level Control:** When the external control signal is a level signal, setting a low or high level to change the direction.

Pulse Control X		Level Control X	
Falling edge	<input checked="" type="radio"/>	Low Level	<input checked="" type="radio"/>
Rising edge	<input type="radio"/>	High level	<input type="radio"/>

Figure 22 Pulse Signal and Level Signal

Calibration - To enhance the accuracy of liquid delivery, it is necessary to calibrate the flow rate (see section 6.3). Follow the prompts of the calibration wizard to ensure that the displayed value accurately corresponds to the actual flow rate. The flow rate calibration must be performed for precise flow display.

System - To set the system parameters of the pump, one can swipe up and down the screen to view the menu, as shown below.

System Settings		System Settings	
Date Settings 2024-02-15	>	Near End of Run Notice 0%	
Time Settings 12:34	>	Motor Stall Alert No	
Language Settings English		Auto Restart Enabled	
BackLight Settings 50%	↩	Factory Reset	↩

Figure 23 System Settings

- **Date Settings:** Set the current year, month, and day.

Date Settings						
December 2017						
Mo	Tu	We	Th	Fr	Sa	Su
				1	2	3
4	5	6	7	8	9	10
11	12	13	14	15	16	17
18	19	20	21	22	23	24
25	26	27	28	29	30	31

Figure 24 Date Setting

- **Time Settings:** Set hour, minute, and second by using the UP and DOWN buttons.

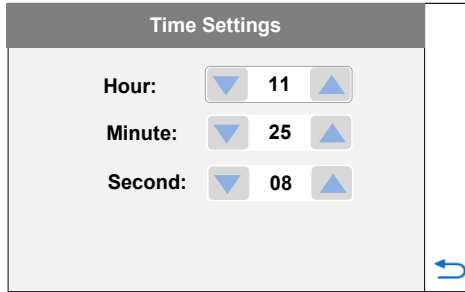

Figure 25 Time Setting

- **Language Settings:** Choose the display language, Chinese or English.

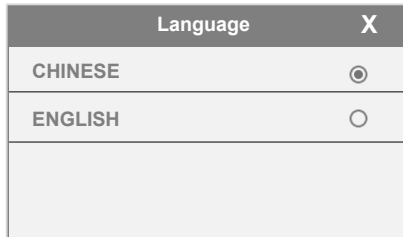

Figure 26 Language Settings

- **Backlight Settings:** The backlight settings of the LCD screen control the brightness level of the screen's backlight. The brightness settings are represented as a numerical scale ranging from 1 to 100, with 1 being the dimmest and 100 being the brightest setting.
- **Near End of Run Notice:** This alarm can be customized to alert the operator when a run is nearing completion. Users can specify a custom percentage of completion. For instance, in a volume dispense run of 100 cycles, setting the value to 85% would trigger the alarm when 85 cycles are completed.
- **Motor Stall Alert:** The motor stall alert is a safety feature designed to notify users when the pump experiences a stall condition, indicating a potential malfunction or problem. When a motor stalls, it means that the motor has stopped rotating despite receiving

power. It triggers the alarm to alert the user of the stall condition.



- **Auto Restart:** Enabling this feature activates the power loss recovery functionality. When power is restored, the pump resumes its operation from the state it was in before the power loss occurred. This feature is applicable only in Flow Mode.
- **Factory Reset:** To reset the pump to its original factory settings. Restart the pump to apply the settings. Alternatively, users can also reset the pump by pressing and holding the direction  key and mode  key when powering up the pump. Release the keys after a beep.



Figure 27 Factory Reset

Info - Access information about the usage of the peristaltic pump.

Information	Information
Software BOOT: V3.1.1 USER: V3.2.1	Hardware 16M FLASH
Hardware 16M FLASH	Speed 0.1rpm 0.2%
Speed 0.1rpm 0.2%	Temperature 33°C/91°F
Temperature 33°C / 91°F	SN 6875

Figure 28 Information

Password - A password is needed to unlock the screen and access the advanced menu.

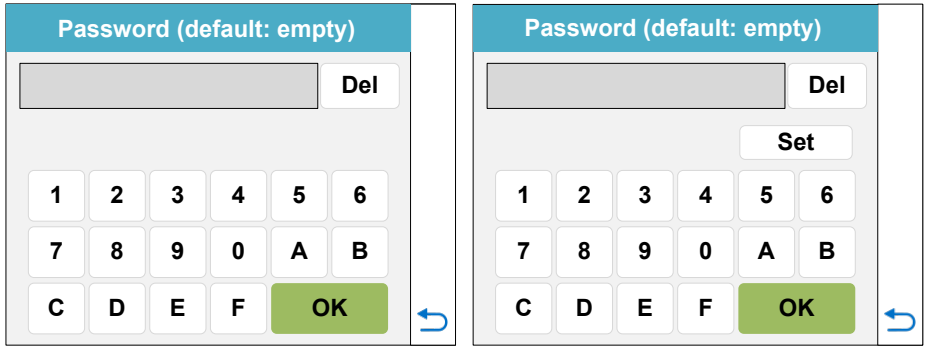
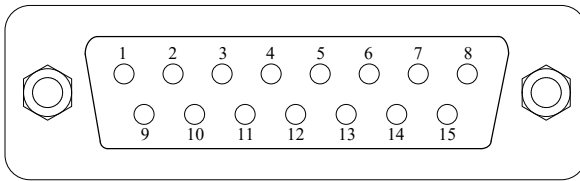

Figure 29 Password Setting

If a password was set, input it, and press OK. This will allow you to return to the General Settings to access the advanced menu (see Figure 21). If no password is set, press OK directly to proceed to the General Settings. To set or change the password, press “Password” again, enter the desired password, and press “Set” to confirm the changes.

Return - Return to the main screen.

5 External Control Interface



DB15	Mark	Note
1	ADC_W	Positive of external analog input
2	B	Communication interface, B pole of RS485
3	A	Communication interface, A pole of RS485
4	VCC_W	External DC power input
5	DAC	Analog voltage signal output
6	CW_W	External input signal to control the direction
7	PWM	Pulse signal output
8	COM	Ground of external power
9	AGND	Negative analog signal input
10	+12V	Positive of internal +12V power source

11	GND	Ground of internal power source
12	CW	Direction signal output
13	RS_W	External start/stop signal input
14	PWM_W	External pulse signal input
15	RS	Internal start/stop signal output

Table 1 External Control Definition

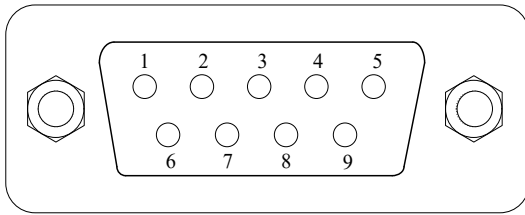

No. DB9	Mark	Note
1		
2	RXD	Receiving data
3	TXD	Send data
4		
5	GND	Signal ground line
6		
7		
8		
9		

Table 2 RS232 Definition

6 Operation Instructions

6.1 Before Operation

- 1) Check the packing slip to ensure all parts are included and in good condition. Contact the manufacturer or distributor if there are any issues.
- 2) Read the instructions thoroughly.
- 3) Check the power supply voltage and ensure it matches the pump's requirements.

- 4) Make sure the pump head is properly installed and securely tightened.
- 5) Ensure the tubing is correctly installed and secured in the pump head before starting the pump. Inspect the tubing for any cracks or defects before operation.
- 6) Connect any required external devices, such as a footswitch or analog input signal, before powering on the pump.
- 7) Ensure the pump is placed on a stable surface to prevent it from moving during operation. Maintain a minimum clearance of 200mm behind the pump during operation.
- 8) Remove any obstacles or debris around the pump that may interfere with its operation.

6.2 Power Connection

Ensure that the power supply voltage matches the rating on the pump label. Connect the power cord to the IEC Power Connector at the rear of the pump, and plug the other end into an electrical outlet. Turn on the rear power switch.

6.3 First Run Wizard

Flow Rate Calibration

Calibrate the flow rate in the following situations:

- First time using the pump
- The pump head is changed
- Tubing is installed or replaced
- Transfer fluid in one channel with dual pump heads
- After prolonged continuous operation

Steps for Flow Rate Calibration

- 1) Install the pump head and tubing.
- 2) Select the pump head and tubing in the General Settings.
- 3) Press the prime key to fill the tubing with liquid.
- 4) When the pump is not running, press  or select the **Calibration** icon in the Main Menu.
- 5) The calibration wizard displays the currently selected tubing, flow rate, and fluid volume.

Calibration		1/3
Welcome to the Calibration Wizard. Please set volume and flow rate for testing. Recommended volume: More than 6.000ml for accuracy, or the desired volume for volume dispense.		
Volume:	<input type="text" value="6.000"/>	<input type="text" value="mL"/>
Flow:	<input type="text" value="9.000"/>	<input type="text" value="mL/min"/>
		<input type="button" value="▶"/>
		<input type="button" value="↶"/>

Figure 30 Flow Rate Calibration

As illustrated in Figure 30, the target flow rate is configured at 9.000 mL/min, accompanied by a minimum test fluid volume of 6.000 mL. To modify the values or units, simply press the appropriate buttons. Press ▶ to enter the calibration window, or press ↶ to exit the wizard.

Note: Ensure the fluid volume is not below the suggested value.

- 1) The test window is shown below.

Calibration		2/3
<input type="button" value="■"/> <input type="button" value="↶"/> Press START/STOP to test, then input the test result. Repeat 3 times.		
Test1:	<input type="text" value="0.000"/>	<input type="text" value="mL"/>
Test2:	<input type="text" value="0.000"/>	<input type="text" value="mL"/>
Test3:	<input type="text" value="0.000"/>	<input type="text" value="mL"/>
		<input type="button" value="▶"/>
		<input type="button" value="↶"/>
0%		

Figure 31 Calibration



Press the Start/Stop key to initiate the fluid transfer for testing. Wait for the pump to complete the test, then measure the delivered volume. Repeat these steps multiple times, entering the results for Test1, Test2, and Test3 in the calibration window. Verify the unit is correct, then press ▶ to proceed to the Calibrate Calculate screen. To modify the test values for flow rate and volume, press ◀ and re-enter the values. Press ↶ to exit the calibrate wizard and return to the system parameter interface. The system will automatically calculate the average value using the entered

test data.

Note: To interrupt the test, press the Start/Stop key. Press it again to restart the test.

The calibration results are calculated, and the previous value is displayed for reference. The new and old values may differ. If the ratio of new to old value is below 0.5 or above 2, check the following:

- Accuracy of volume measurement
- Volume unit setting
- Pump head model setting
- Tubing size setting
- Liquid viscosity (high viscosity may affect flow rate linearity)
- Use of dual pump heads for one channel

If no issues are found, press  to save the new value. Otherwise, press  to retest or press  to exit without saving and return to the Main Settings window.





Calibration		3/3
After analysis and calculation, the results are as follows:		
Average volume	6.017 mL	
Calculated scale	106.3707	
Reference scale	106.6662	
Old scale	106.6662	

Figure 32 Calibrate Result

If no data has been entered, the following window will be displayed. Press  to perform the test again.

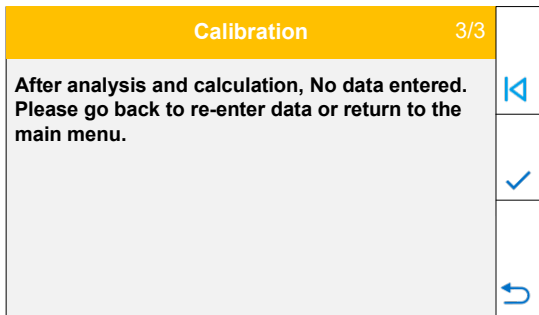

Figure 33 No Data Entered

6.4 Working Mode

When the pump is not running, press MODE key to enter the Working Mode window, as shown below.

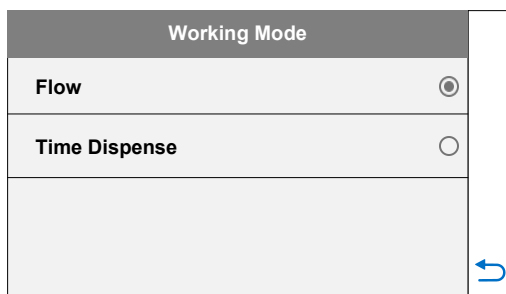

Figure 34 Working Mode

- **Flow Mode**

The pump operates based on the set flow rate and records the cumulative fluid volume.

In the main screen, the flow and flow unit can be set and the flow rate can be adjusted using the increase and decrease icons. The preview screen displays the pump head model, tube size, current operation time, and liquid volume.

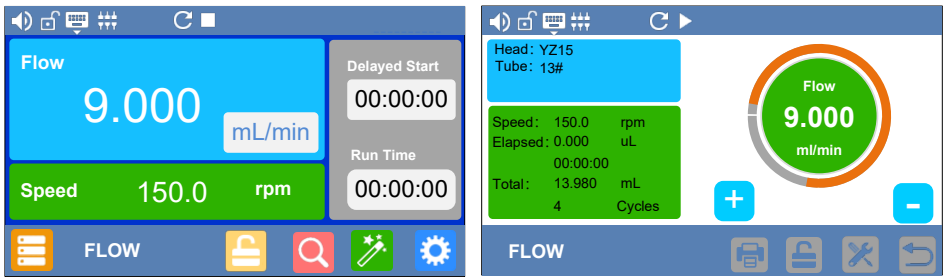

Figure 35 Flow Interface

In the flow mode, delayed start and run time can be customized in pop-up windows. Figure 36 illustrates an example with an automatic start scheduled in 30 minutes, and an automatic stop after 1 hour and 30 minutes of operation.

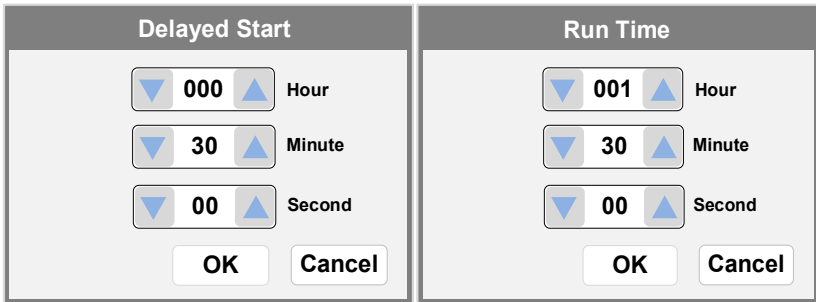

Figure 36 Delayed Start and Run Time Setting

Once the time is set, press the **START/STOP** key to initiate the delay process. A **clock** icon will appear in the status bar, indicating the delay is active, as shown below.

Note: If the run time is set to 0, the delay process cannot be initiated.

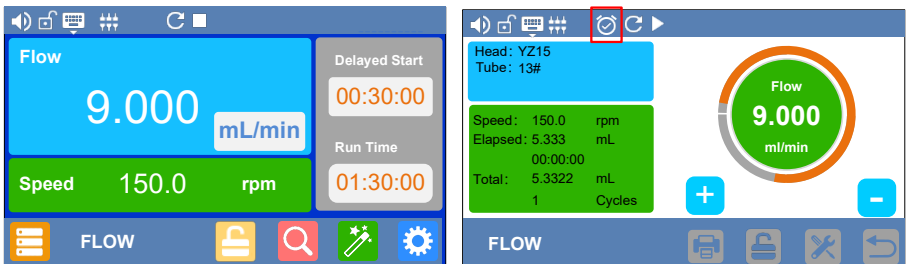

Figure 37 Alarm Icon on the Status Bar

● **Time Dispense Mode**

In this mode, the pump dispenses fluid by configuring the dispense duration for each dose, the pause time between doses, and the number of cycles. The system automatically calculates the dispense volume for each dose.



Set Up

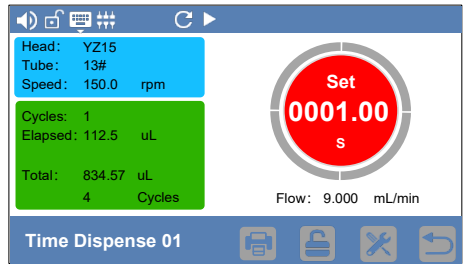

Preview

Figure 38 Time Dispense Mode

Run: Dispense duration for each dose.

Flow: Dispense flow rate in uL/min, mL/min, or L/min.

Pause: Pause time between doses in seconds, minutes, or hours.

Cycles: Dispensing cycles. If set to zero, the pump will continue running until the START/STOP key is pressed. If set to 1, the pump will run only once, and the pause time setting is not applicable. For a value greater than 1, the pump will run the specified number of cycles and then stop.

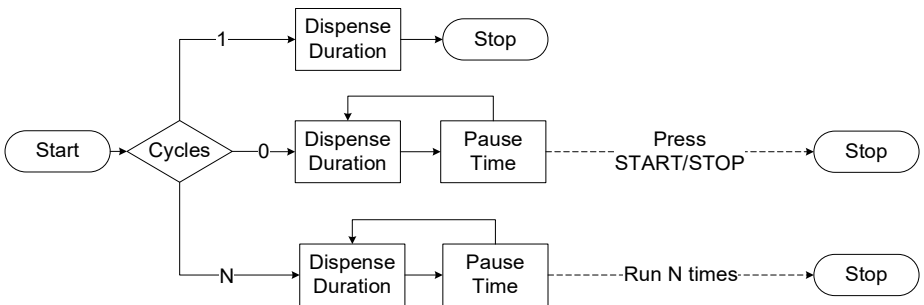



Figure 39 Time Dispense Cycles

The preview interface displays the current pump head, tubing size, the number of cycles completed, and the volume transferred.

The current setting will be saved to the “Time Dispense 01” group. To recall a different group of settings, press , select a group number in the window, and then return to the dispense mode window. If you modify the settings, they will be saved to the current group. There are 5 groups available for use.

Mode Settings	
Dispense NO.1	
Reserved	
Sound	<input checked="" type="checkbox"/>
Reserved	

Figure 40 Time Dispense Mode Settings

6.5 External Control Mode

The external control mode allows analog signal control of the pump speed and logic signals control of the start/stop and direction. The keypad is disabled.

- 1) Power off the pump. Connect the DB15 connector according to the wiring diagrams shown below and plug it into the DB15 port located at the rear of the pump.

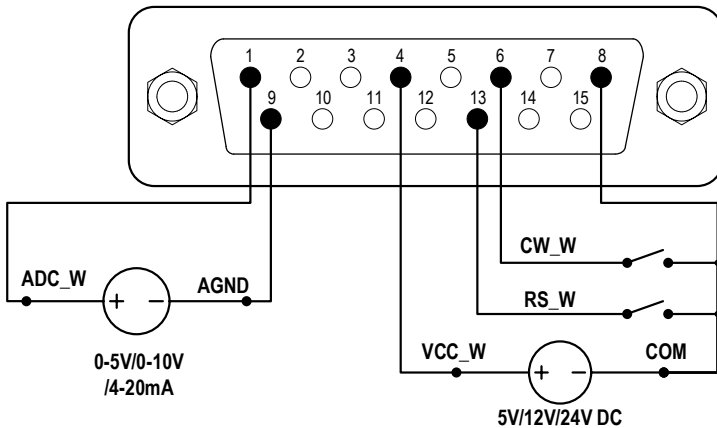

Figure 41 DB15 Wiring with External DC Power Source

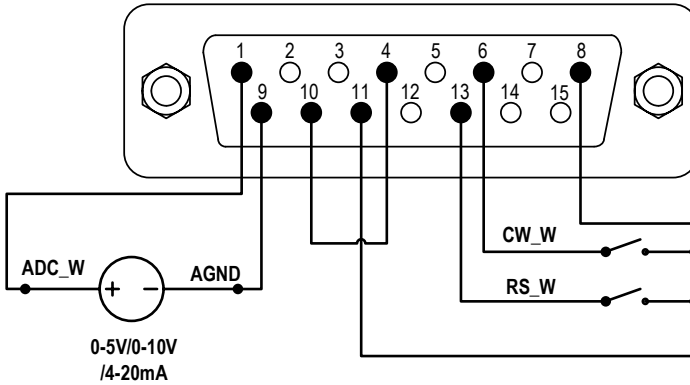
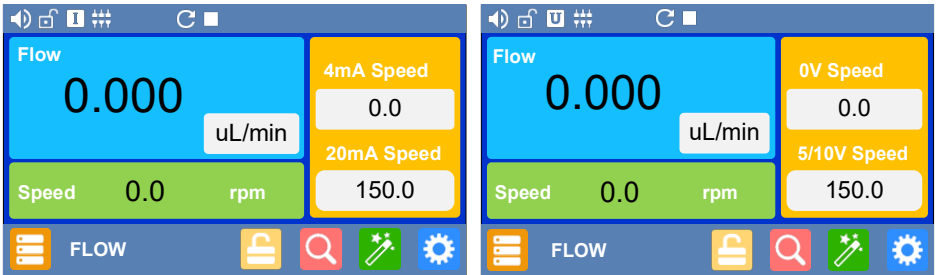

Figure 42 DB15 Wiring with Internal 12V DC Power Source

- 2) Power on the pump. The main screen will be displayed.
- 3) Press the MODE key to select the flow mode.
- 4) Select either voltage mode or current mode in the control mode settings.



Current Control Mode

Voltage Control Mode

Figure 43 Analog control interface

When the External Control Mode is set to Logic Level and the external RS_W switch is closed, the pump will run and the speed will vary based on intensity of the analog input signal. Opening the RS_W switch will stop the pump. When the CW_W switch is opened, the pump will rotate clockwise, and when it is closed, the pump will rotate counterclockwise.

When the External Control Mode is set to Pulse, closing and then opening the external RS_W switch will start the pump, and the speed

will change according to the analog input signal. Closing and opening the RS_W switch again will stop the pump. Closing and then opening the CW_W switch will make the pump rotate clockwise, and closing and opening it again will make the pump rotate counterclockwise.

Note: The external DC power source can be 5V, 12V, or 24V.

6.6 Communication mode

The RS485 interface of the pump supports the standard MODBUS protocol, allowing control of the pump through an external device via the communication port. Please refer to the [Communication Instruction Manual](#) for parameter details and supported commands.

- 1) Power off the pump. Connect the DB15 connector according to the wiring diagrams shown in [Figure 44](#) or [Figure 45](#), and connect it to the DB15 port at the rear of the pump.

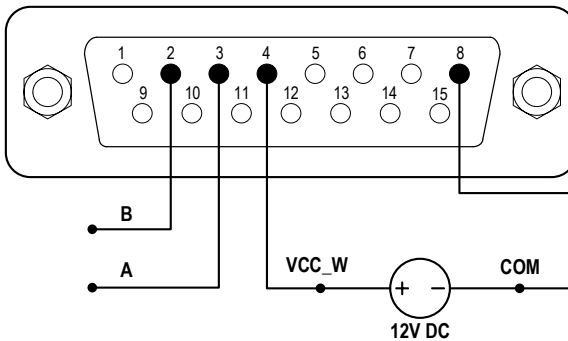

Figure 44 Control Start/Stop with an External 12V Power Source

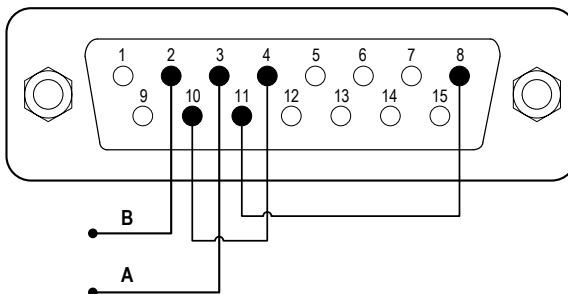

Figure 45 Control Start/Stop with an Internal 12V Power Source

2) Power on the pump. The main screen will be displayed.

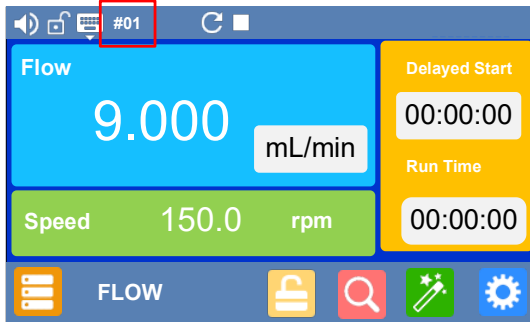

Figure 46 Communication Connected

- 3) When the main screen shows the pump number (e.g., #01) in the Internal Control Mode, it indicates that the communication is connected. Otherwise, the communication is disconnected.
- 4) The peristaltic pump communicates through RS485 with default settings of 9600 communication rate, 8 data bits, even parity check, and 1 stop bit. These parameters can be modified in the common parameters of the communication settings, as shown in [Figure 47](#). Once successfully connected, the pump's functions can be controlled by an external device.

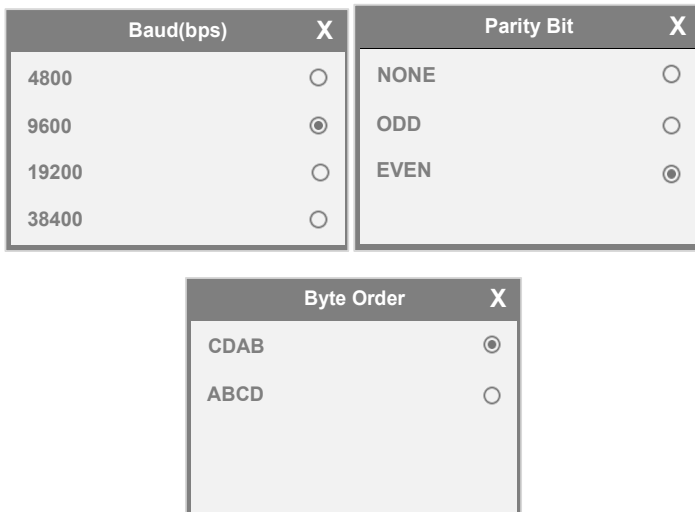

Figure 47 Communication Interface

6.7 Footswitch

Power off the pump. Connect the DB15 connector according to the wiring diagrams shown in Figure 48 or *Figure 49*, and plug it into the DB15 port located at the rear of the pump. Power on the pump. The main screen will be displayed.

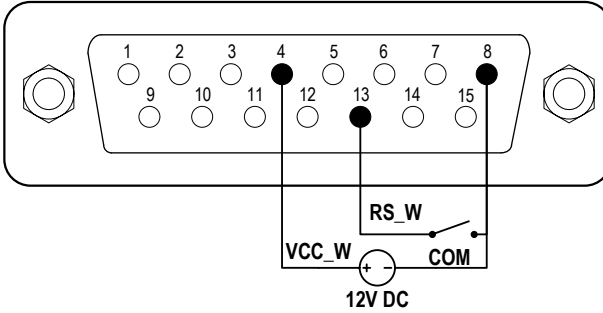

Figure 48 Footswitch Control Start/Stop with an External 12V Power Source

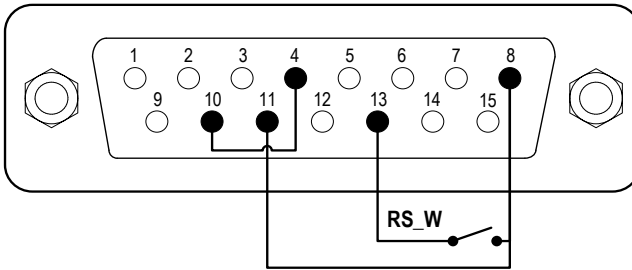

Figure 49 Footswitch Control Start/Stop with the Internal 12V Power Source

If the External Control is set to Logic Level in the Footswitch Control Mode, the pump will start when the RS_W switch is closed and the pump will stop when the switch is opened.

If the External Control is set to Pulse in the Footswitch Control Mode, the pump will start when the RS_W switch is closed and then opened and the pump will stop when the switch is closed and then opened again.

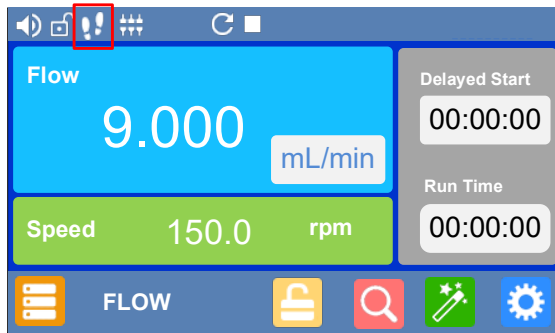

Figure 50 Footswitch Control

7 Maintenance

7.1 Warranty

The drive includes a 3-year warranty covering both labor and parts. Please note that the warranty does not cover any damage resulting from improper usage or mishandling.

7.2 Regular Maintenance

To ensure optimal performance, please follow these maintenance guidelines:

- 1) Regularly inspect the tubing and connections to prevent leakage.
- 2) Do not cover the fan located at the rear of the pump.
- 3) Avoid exposing the pump head to water. Keep it dry.
- 4) Refrain from using chemical solvents to clean the pump and pump head.

7.3 Malfunction Solutions

No.	Malfunction	Description	Solution
1	Hardware	No display	<ol style="list-style-type: none"> 1. Check the power cord. 2. Check the fuse. If it was blown, replace it with a 1A slow-blow fuse 3. Check the internal power cord connection inside the pump. 4. Check the wire connection between the LCD and the main control

Golander BT100L/300L/600L Intelligent Flow Peristaltic Pump

			board.
2	Hardware	Motor does not work	<ol style="list-style-type: none"> 1. Check the indicator of the driver board. 2. Check the wire connection between the motor and the driver board. 3. Check the wire connection between the driver and the main board. 4. Check the power voltage for the pump.
3	Hardware	Motor vibrates	<ol style="list-style-type: none"> 1. Check the wire connection between the motor and the driver board. 2. The motor is overloaded. Check the mechanical connection.
4	Hardware	Motor runs in one direction only	Check the connection between the drive board and the main control board.
5	Hardware	Keypad does not work	<ol style="list-style-type: none"> 1. Check the wire connection between the keypad and the main board. 2. Check if the key is broken.
6	Hardware	External control does not work	<ol style="list-style-type: none"> 1. Check the wiring of the connector. 2. Check if the external control power voltage is provided. 3. Check the connections of the external control board.
7	Hardware	RS485 com does not work	<ol style="list-style-type: none"> 1. Check the wiring of the connector. 2. Check if the external control power voltage is provided. 3. Check the connections of the communication board.
8	Hardware	Noisy when running	Check the screws and lever on the pump head to make sure they are secure.
9	Software	External control does	Check if the pump is in External Control Mode.

		not work	
10	Software	RS485 does not work right	<ol style="list-style-type: none"> 1. Check if the display shows the communication is ready. 2. Reset the address of the pump. 3. Check whether on the bus there are two pumps using the same address



If a problem cannot be solved, please contact the manufacturer or distributor for assistance.

8 Dimensions

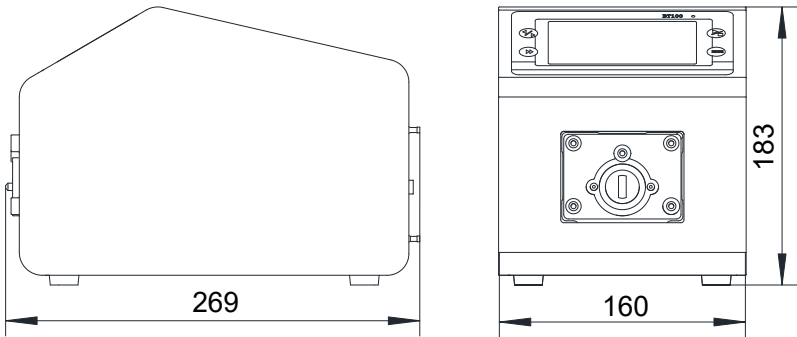
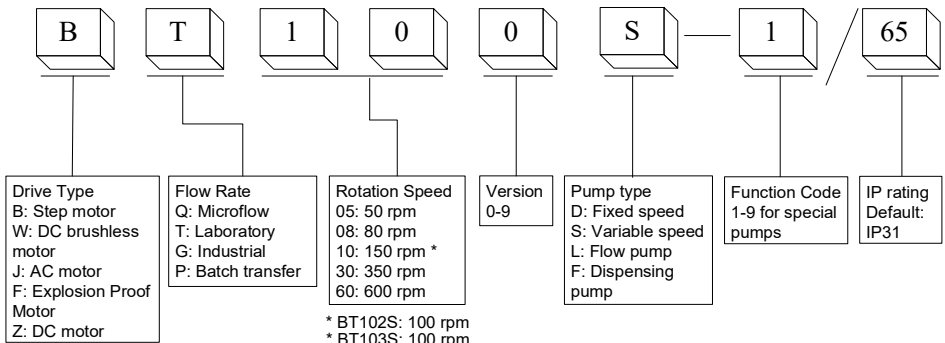

Figure 51 Dimensions (mm)

9 Naming Rule



10 Specifications

Speed resolution	0.1 rpm
Speed accuracy	0.2%
Power supply	AC 100-240V 50Hz/60Hz
Power consumption	BT100L: <40W BT300L: <50W BT600L: <60W
Logic level control signal	5V, 12V, 24V
External analog control signal	0-5V, 0-10V, 4-20mA
Communication interface	RS485 MODBUS
Operating condition	Temperature 0-40°C, Relative humidity <80%
IP grade	IP31
Display	TFT 4.3" Touch Screen LCD
Dimensions (LxWxH)	269X160X183mm
Weight	5.5Kg

BT100L Suitable Pump Heads and Tubing, Flow Parameters

Pump head	No. of Channels	Tubing size (mm)	Flow rate per channel (mL/min)
DG6-1 (6rollers)	1	Wall:0.8~1, ID:≤2.4	0.00016~26
DG10-1(10rollers)	1	Wall:0.8~1, ID:≤2.4	0.00011~20
DG6-2 (6rollers)	2	Wall:0.8~1, ID:≤2.4	0.00016~26
DG10-2 (10rollers)	2	Wall:0.8~1, ID:≤2.4	0.00011~20
DG6-4 (6rollers)	4	Wall:0.8~1, ID:≤2.4	0.00016~26
DG10-4 (10rollers)	4	Wall:0.8~1, ID:≤2.4	0.00011~20
DT10-18	1	13# 14#, Wall:0.8~1, ID:≤3.17	0.0002~82
DT10-28	2	13# 14#, Wall:0.8~1, ID:≤3.17	0.0002~82

Golander BT100L/300L/600L Intelligent Flow Peristaltic Pump

DT10-48	4	13# 14#, Wall:0.8~1, ID:≤3.17	0.0002~82
YZ15	1	13# 14# 16# 19# 25# 17#	0.0006~420
YZ25	1	15# 24#	0.16~420
2xYZ15	2	13# 14# 16# 19# 25# 17#	0.0006~420
2xYZ25	2	15# 24#	0.16~420
YT15	1	13# 14# 16# 19# 25# 17# 18#	0.006~570
YT25	1	15# 24# 35# 36#	0.17~720
2xYT15	2	13# 14# 16# 19# 25# 17# 18#	0.006~570
2xYT25	2	15# 24# 35# 36#	0.17~720
DT15-14	1	16# 19# 25# 17#	0.05~400
DT15-24	2	16# 19# 25# 17#	0.05~400
DT15-44	4	16# 19# 25#	0.05~260

BT300L Suitable Pump Heads and Tubing, Flow Parameters

Pump head	No. of Channels	Tubing size	Flow rate per channel (mL/min)
YZ15	1	13# 14# 16# 19# 25# 17#	0.006~990
YZ25	1	15# 24#	0.16~990
2xYZ15	2	13# 14# 16# 19# 25# 17#	0.006~990
2xYZ25	2	15# 24#	0.16~990
YT15	1	13# 14# 16# 19# 25# 17# 18#	0.006~1300
YT25	1	15# 24# 35# 36#	0.16~1600
2xYT15	2	13# 14# 16# 19# 25# 17# 18#	0.006~1300
DT15-14	1	16# 19# 25# 17#	0.05~930
DT15-24	2	16# 19# 25# 17#	0.05~930
DT15-44	4	16# 19# 25#	0.05~610

BT600L Suitable Pump Heads and Tubing, Flow Parameters

Pump head	No. of Channels	Tubing size	Flow rate per channel (mL/min)
YZ15	1	13# 14# 16# 19# 25# 17# 18#	0.006~1700
YZ25	1	15# 24#	0.16~1700
2xYZ15	2	13# 14# 16# 19# 25# 17# 18#	0.006~1700
2xYZ25	2	15# 24#	0.16~1700
YT15	1	13# 14# 16# 19# 25# 17# 18#	0.006~2300
YT25	1	15# 24# 35# 36#	0.16~2900
2xYT15	2	13# 14# 16# 19# 25# 17# 18#	0.006~2300

Golander LLC

4405 International Blvd
Ste B117, Norcross, GA 30093
USA

Tel: +1 678-587-8806
info@golanderpump.com
www.golanderpump.com

Golander GmbH

Dechant-Heimbach-Str. 29
53177 Bonn
Germany

Tel: +49 228 50446952
info@golander.de
www.golander.de